

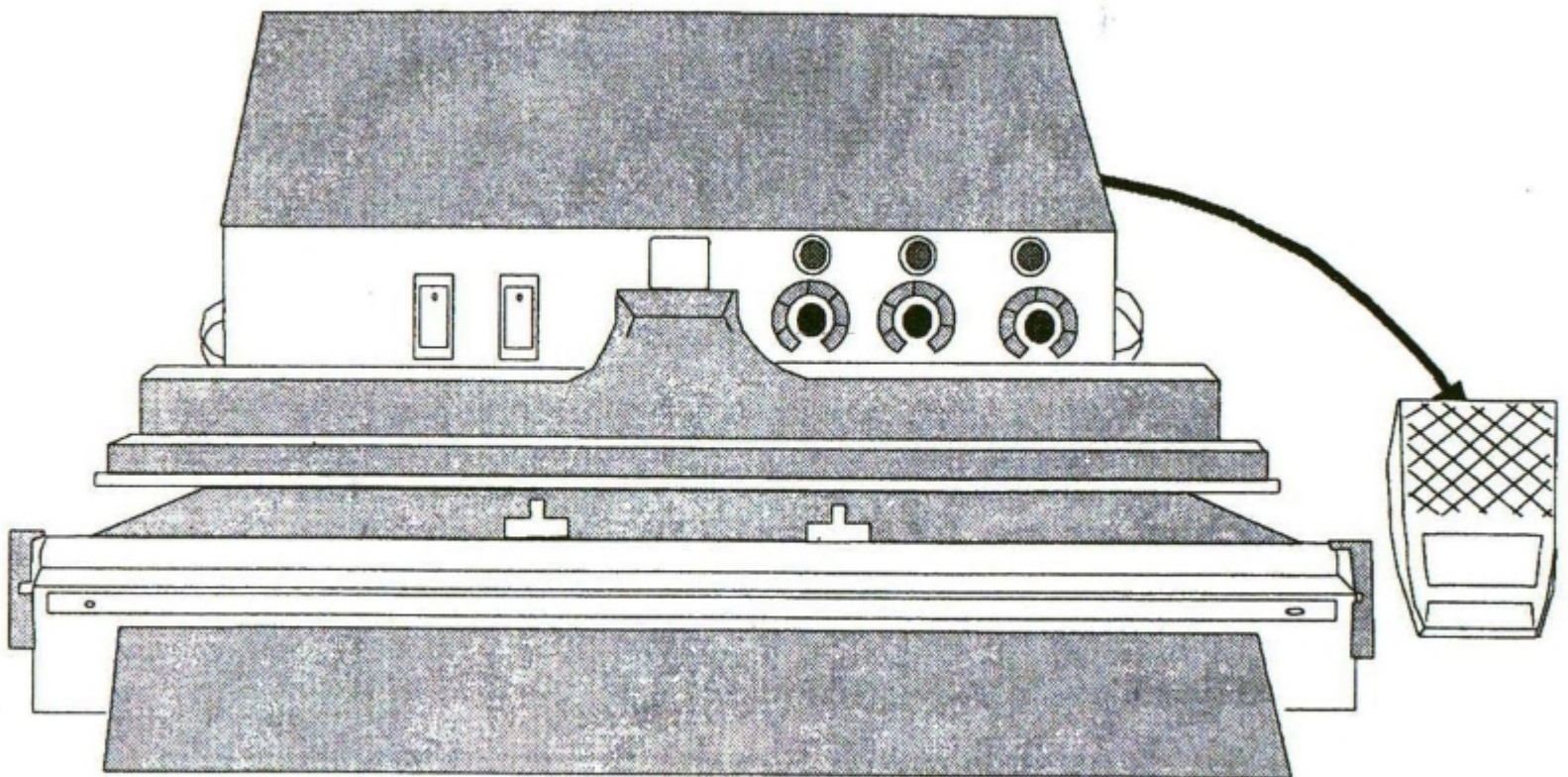

**BOATMAN
MARKING**

Packaging Supplies & Equipment

IMPULSE AUTOSEALER AIE-300A1, 450A1, 600A1 INSTRUCTION



1 INSTRUCTION BOOKLET

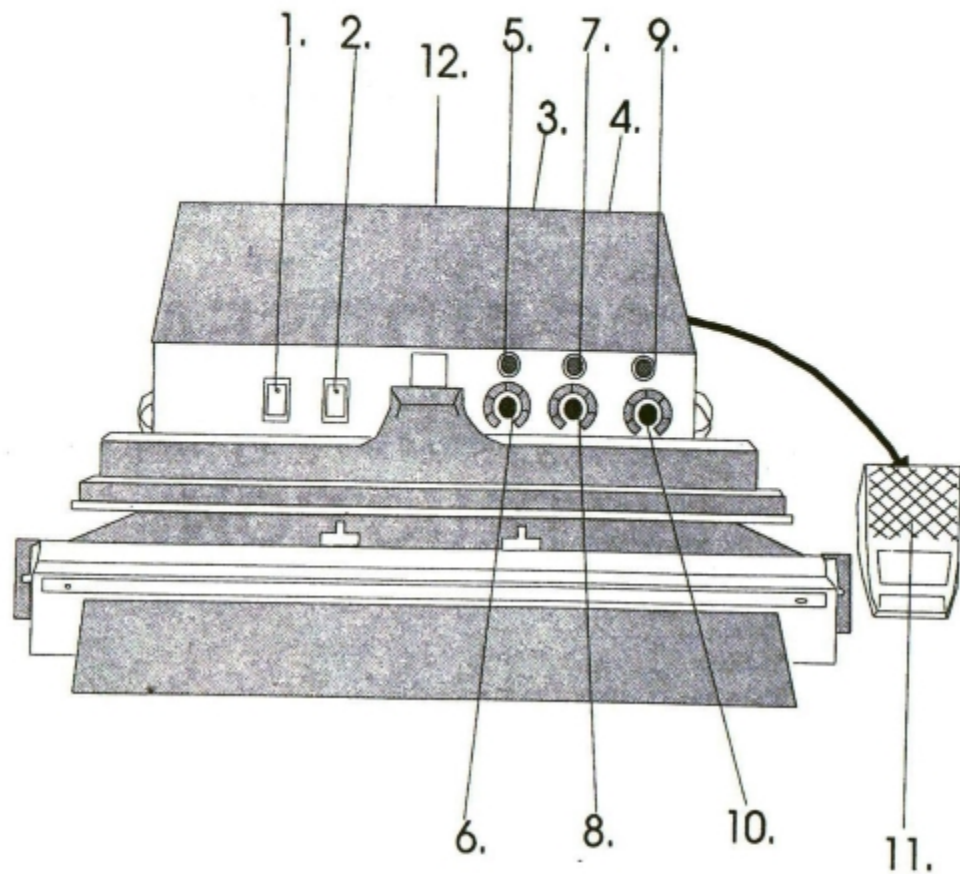

1. Power Main Switch
2. AUTO-MAN Action Selector
3. 10 A Fuse Box
4. 1 A Fuse Box
5. Re-Cycle Indicating Lamp (RED)
6. Re-Cycle Timer Control Knob
7. Congealing Indicating Lamp (RED)
8. Congealing Timer Control Knob
9. Sealing Indicating Lamp (RED)
10. Sealing Timer Control Knob
11. Foot Pedal Switch
12. Fuse

2 OPERATING INSTRUCTION

- (1) Set power main switch to ON position.
- (2) Set selector to MAN position for manual operation by pressing the foot pedal switch, or set selector to AUTO position for automatic operation.
- (3) Adjust the re-cycle time knob, appropriate to the frequency of continuous work.
- (4) Adjust the sealing time (heating time) knob, appropriate to the thickness of plastic bag.
- (5) Adjust the congealing time (pressing time) knob, appropriate to the thickness of seal (to be cooled).

NOTE: Sealing and congealing time are according to the material and thickness of the plastic bags. Re-cycle time is according to the working speed of the operator.

3 SPECIFICATIONS:

MODEL	AIE-300A1	AIE-450A1	AIE-600A1
Source	110V	110V	110V
Impulse Power	600W	700W	900W
Max. Seal Length	350mm	450mm	600mm
Max. Seal Thickness	0.6mm	0.6mm	0.6mm
Heat Time	0.2~3.0sec.	0.2~3.0sec.	0.2~3.0sec.
Congealed Time	1.0~8.0sec.	1.0~8.0sec.	1.0~8.0sec.
Reset Time	1.0~8.0sec.	1.0~8.0sec.	1.0~8.0sec.
Weight	46 LBS	51 LBS	60 LBS
Dimensions	20*17*10 inch	24*17*10 inch	29*17*10 inch

4 CONSTRUCTION DIAGRAM

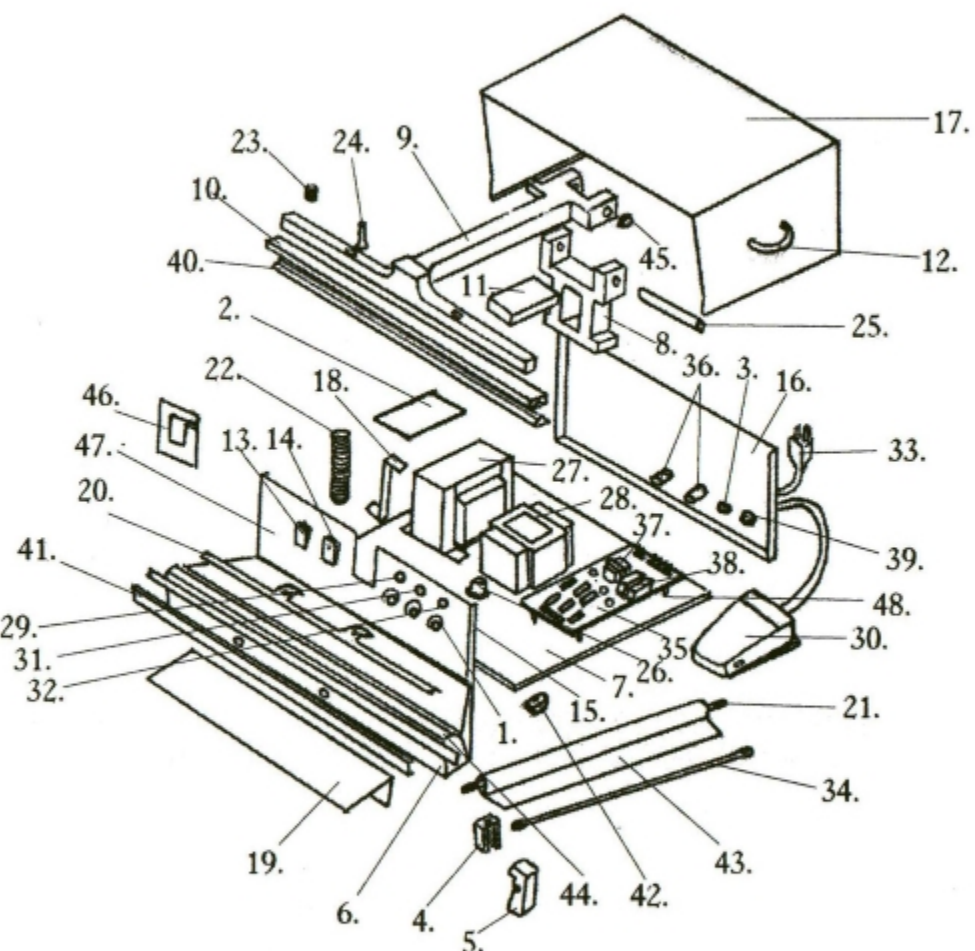

5 PARTS LIST

- | | |
|--------------------------------|--------------------------|
| 1. TIMER KNOB | 25. HINGE PIN |
| 2. PLASTIC PLATE | 26. SPRING BRACKET |
| 3. BUSHING | 27. TRAMS FORMER |
| 4. Heating Element Attachment | 28. SOLENOID |
| 5. END CAP | 29. RE-CYCLE TIME |
| 6. LOWER JAW | 30. FOOT SWITCH |
| 7. BASE PLATE | 31. CONGEALING TIME |
| 8. HINGE BRACKET | 32. SEALING TIME |
| 9. UPPER JAW | 33. POWER SUPPER CORD |
| 10. UPPER JAW SUPPORT | 34. HEATING ELEMENT |
| 11. FLAT PLATE | 35. CONTROL-PCB |
| 12. HANDLE STRAP | 36. FUSE BRACKET |
| 13. ON/OFF SWITCH | 37. PCB-TRAMS FORMER |
| 14. Auto-Manu. Action Selector | 38. RELAY |
| 15. FRONT PLATE | 39. CONNECTOR FOOT PEDAL |
| 16. BACK PLATE | 40. SILICON RUBBER |
| 17. TOP COVER PLATE | 41. FIXED TEFLON PLATE |
| 18. SPRING LEVER | 42. RUBBER FOOT |
| 19. OPERATING BOARD | 43. UPPER TEFLON ROLL |
| 20. CLIP FOR CLOTH | 44. BOTTOM TEFLON TAPE |
| 21. SCREW FOR CLOTH | 45. PIN WASHER |
| 22. RETURN SPRING | 46. DUST COVER RUBBER |
| 23. SPRING FOR UPPER JAW | 47. CONTROL PANEL |
| 24. SCREW FOR UPPER JAW | 48. PCB SUPPORT |

6 CONNECTION DIAGRAM

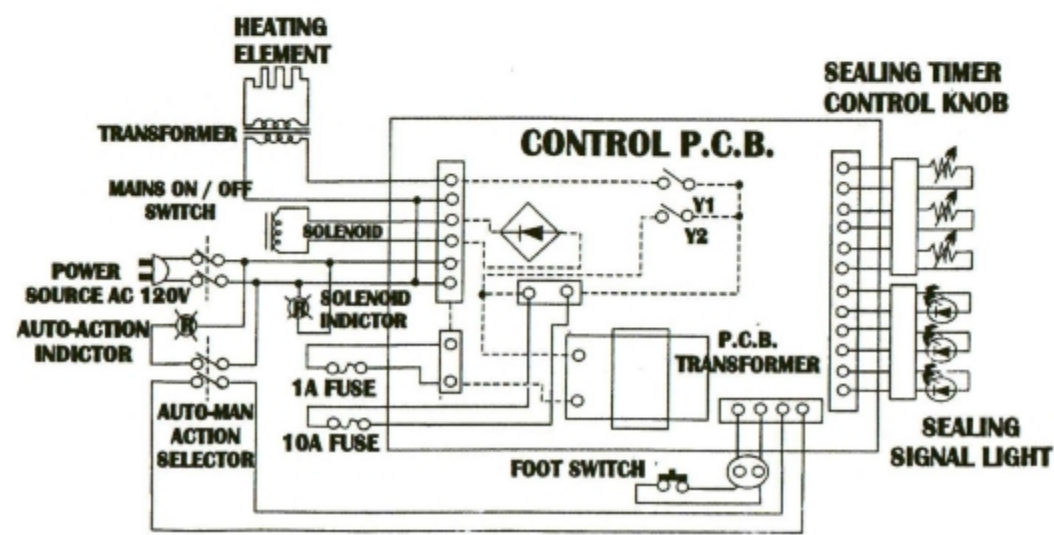

7 ADDITIONAL INFORMATION

- Always keep the sealing platform clean. Particular care should be taken to remove any residue from the teflon tape.
- Do not clean the sealing platform with anything wet.
- If the bottom teflon tape, (under the heating element) should become worn, the heating element may short out and damage the element.
- When replacing the heating element always check the condition of the bottom teflon tape. It is important that you replace the element wire only with the one made for this machine. You can damage the transformer with the wrong element wire.
- Occasionally check the condition of the top pressure pad (silicon rubber) for deformation or severe burn. A poor rubber will effect the quality of your seal.

USE ONLY GENUINE REPLACEMENT PARTS

8 SPARE PARTS

ACCESSORIES	Q'TY
HEATING ELEMENT	2*

9 CHANGING PARTS

To replace burnt out teflon tape or broken element wires please follow these instructions:

REMOVE PLUG FROM ELECTRIC OUTLET.

1. To replace teflon
 - (a) Remove fixed teflon rubber. Loosen teflon clips.
 - (b) Pull out teflon tape just enough to cut off burned area. Smooth out teflon and refix the black rubber.
 - (c) Rotate teflon screw to pull teflon tight. Retighten the teflon clips.
2. Replacing heating element wire
 - (a) Loosen teflon clips. Remove fixed teflon rubber.
 - (b) Lift up teflon and remove broken element wire from heater poles (bow springs).
 - (c) Put new element wire on heater poles. Do not bend or crimp the wire.
 - (d) Replace teflon and teflon rubber. Tighten teflon with teflon screw. Tighten teflon clips.

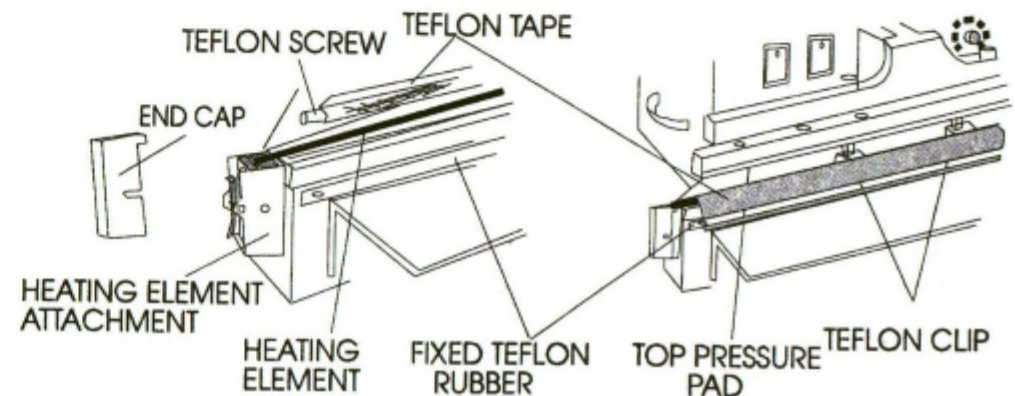

CONSTRUCTION DIAGRAM

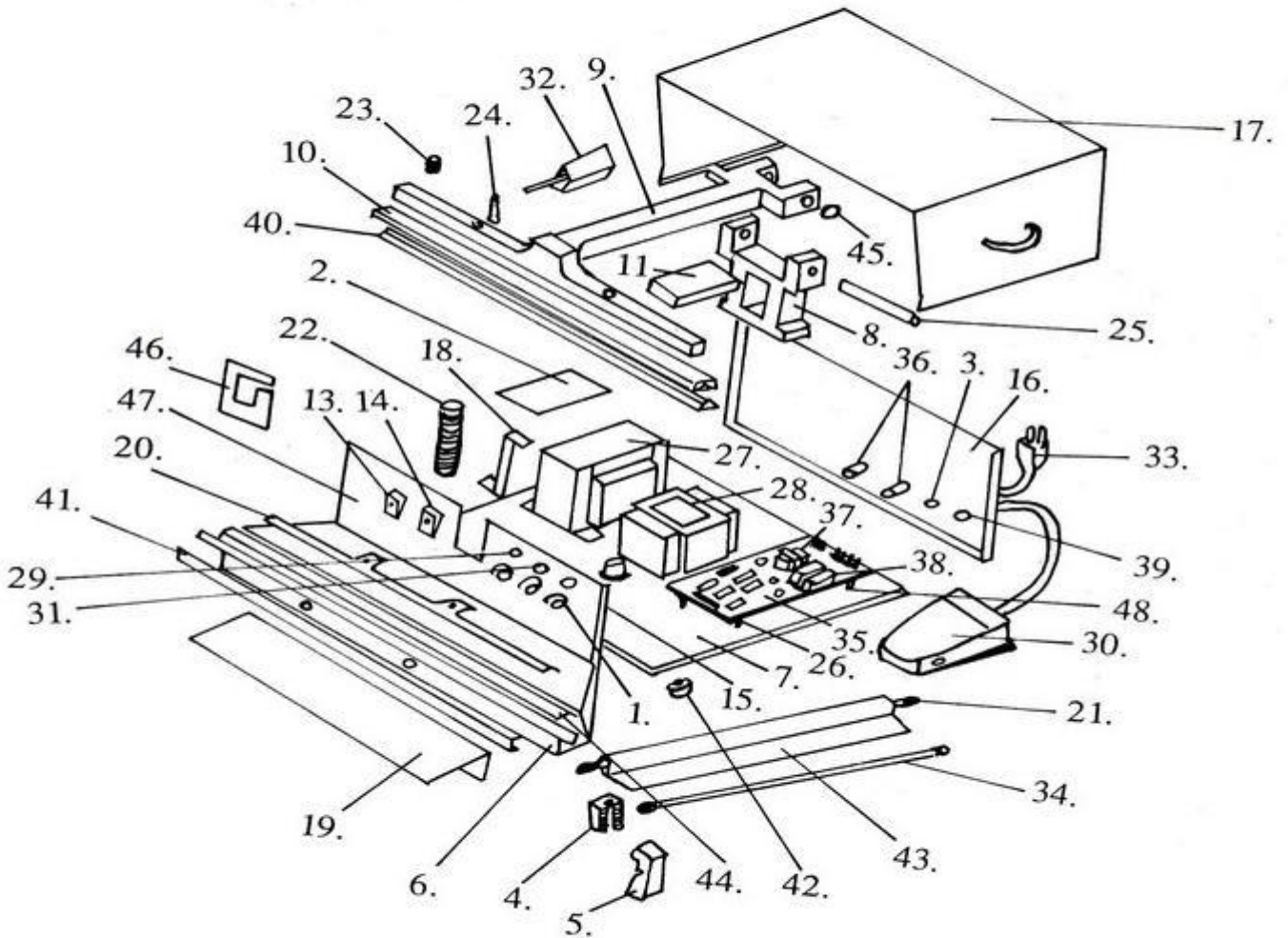

No.	Description	Part Number
1	Timer Knob	*KNOB
2	Plastic Plate	*PLATE#2
3	Bushing	*CORDHO-A
4	Heating Element Attachment	*CAPSETA1
5	End Cap	*ENDCAPA1
6	Lower Jaw	*JAW30-LA
7	Base Plate	*BASE-PLA
8	Hinge Bracket	*HINGE-A1
9	Upper Jaw	*JAW300A1
10	Upper Jaw Support	*UJS300A1
11	Flat Plate	*FLAT
12	Handle Strap	*HANDLE-A
13	ON/OFF Switch	*SW#13
14	Auto-Manu. Action Selector	*SW#14
15	Front Plate	*FRONT-CT
16	Back Plate	*BACK-PLA
17	Top Cover Plate	*COVER-A1
18	Spring Lever	*LEVER-A1
19	Operating Board	*TA300A1
20	Clip for Teflon Roll	*CLIP300
21	Screw for Cloth	*BAR300
22	Return Spring	*RE-SP300
23	Spring for Upper Jaw	*JAWSP-A1
24	Screw for Upper Jaw	*PIN450
25	Hinge Pin	*HINGEPIN
26	Spring Bracket	*SP-BRACK
27	Transformer	*TR300A1
28	Solenoid	*SD300A1
29	Re-Cycle Timer	*VR1M-SET
30	Foot Switch	*FOOTSW
31	Congealing Time	*VRIM-SET
32	Sealing Time	*VRIM-SET
33	Power Supply Cord	*CORD-AF
34	Heating Element	*EF300A1
35	Control-PCB	*PCB-N2
36	Fuse Bracket	*FUSE-BOXA
37	PCB-Transformer	
38	Relay	
39	Connector Foot Pedal	*CONNECTM
40	Silicon Rubber	*SR300A1
41	Fixed Teflon Plate	*FIXTP30A
42	Rubber Foot	*FOOT-A
43	Upper Teflon Roll	*TFS300A1
44	Bottom Teflon Tape	*TFL300A1
45	PIN Washer	*LOCK-A
46	Dust Cover Rubber	*DUST-COV
47	Control Panel	*PANEL-A
48	PCB Support	